

VIBRATION MANAGEMENT CORPORATION

5930 THOMAS ROAD , HOUSTON , TEXAS 77041 , U.S.A

INTERNET ADDRESS: www.vimco.biz

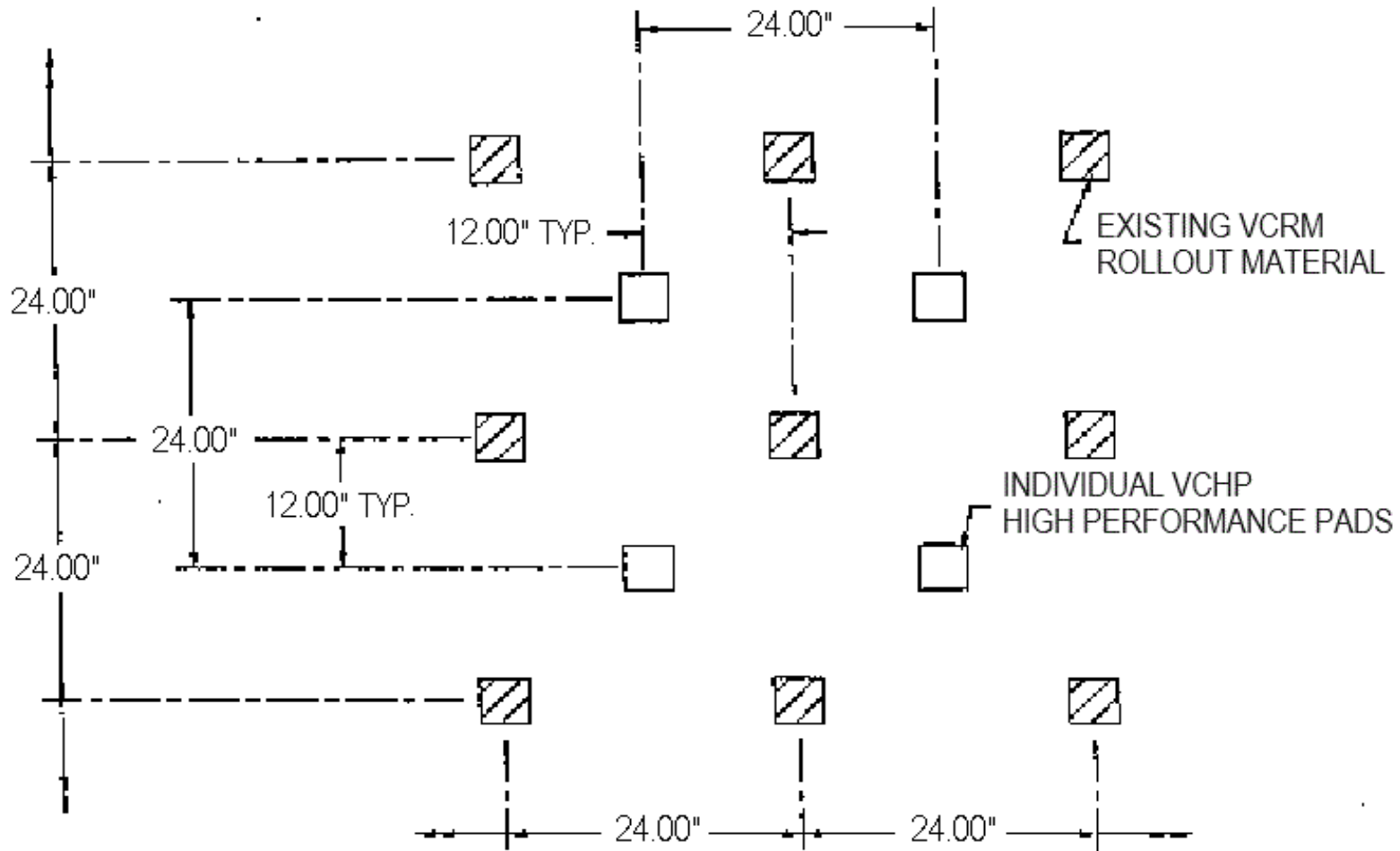

Notes / Remarks :

Project :
 Client :
 Consultant :
 Representative :

Title : High Load Pad Layout on
 VCRM-24-xxxx Rollout Material
 (24" spacing)

Drawing no.
S-2600.09

Rev. 0